

# HSF

**NOTES:**

Voltage Rating: 50V AC/DC  
 Current Raing: 0.5AMP  
 Contact Resistance: 20mΩ max  
 Withstand Voltage: 500V AC/Minute  
 Insulation Resistance: 500MΩ min  
 Operation Temperature: -40°C to +105°C

Contact Material: Phosphor Bronze  
 Contact Plating: 100~200u" Tin Plated Over  
 50~80u" Nickel  
 Insulator Material: PA9T+33%GF UL94V-0 Black

Recommended P.C.B Layout (Top Side)  
 (PCB BOARD TOLERANCE ±0.05)

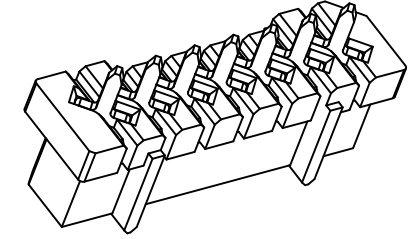
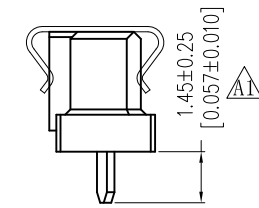
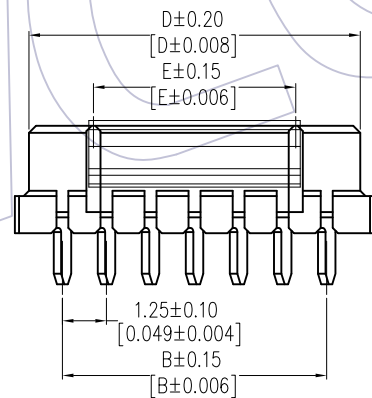
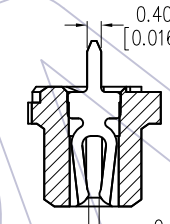
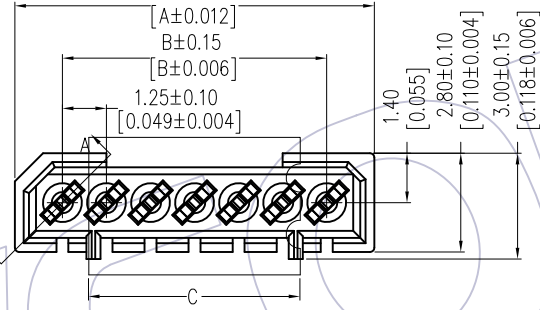
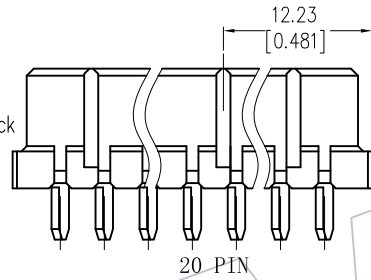
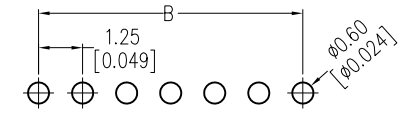
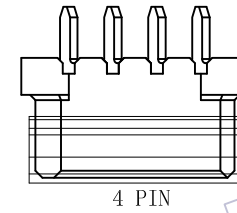
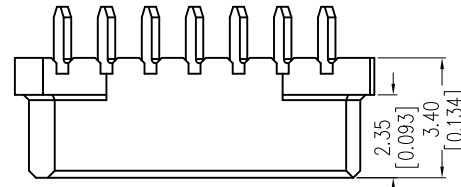
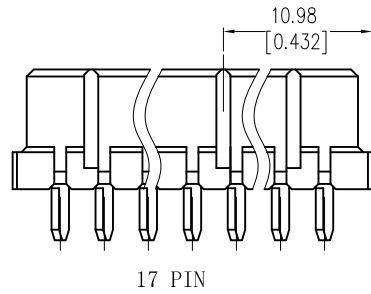

## Ordering Information

3652- S XXX - 034 XX R04

- |             |                   |             |
|-------------|-------------------|-------------|
| No.of Pins  | Plating           | Packing     |
| 004: 04 Pin | G0=Gold Flash     | R=Tape&Reel |
| 005: 05 Pin | G3=10u"Gold       |             |
| 006: 06 Pin | G4=15u"Gold       |             |
| 007: 07 Pin | G5=30u"Gold       |             |
| 008: 08 Pin | S0=Gold Flash/Tin |             |
| 010: 10 Pin | S3=10u"Gold/Tin   |             |
| 017: 17 Pin | S4=15u"Gold/Tin   |             |
| 020: 20 Pin | S5=30u"Gold/Tin   |             |
|             | SN=Tin            |             |

Pos	PART NO.	DIM C
4-7PIN	CAP2521-M201	6.00
17-20PIN	CAP2521-M201	6.00

21.99	25.65	23.75	26.45	20
18.24	21.90	20.00	22.70	17
9.49	13.15	11.25	13.95	10
6.99	10.65	8.75	11.45	8
5.74	9.40	7.50	10.20	7
4.49	8.15	6.25	8.95	6
3.24	6.90	5.00	7.70	5
1.99	5.65	3.75	6.45	4
E	D	B	A	PIN数

REV	DATE	MODIFICATION DESCRIPTION	CHANGE	OPERATION		DRAW	DATE	SCALE	FIT	PART NO.
				X.X	±0.40					
A1	2017.07.11	DIP: 1.30±0.25 → 1.45±0.25	----	X.XX	±0.25	Ding	2017.07.11	UNIT	mm	3652-SXXX-034XXR04
A0	2016.10.20	NEW	----	X.XXX	±0.15	CHECK	DATE	SIZE	A4	TITLE:
				Angle	± 3'	APPROVE	DATE	SHEET	1/1	1.25mm BTB FEMALE, 180° DIP, H=3.4 W/O POST
				DIM	TOL			PROJ.	Customer NO.	

**WCON**  
 Http: www.wcon.com

WCON-Dongguan  
 Tel: +86 769 85358920  
 Fax: +86 769 85358915  
 E-mail: sales@wcon.com

WCON-Kunshan  
 Tel: +86 512 57468408  
 Fax: +86 512 57468468  
 E-mail: salesks@wcon.com