



NOTES:
 Current Rating: 3.0AMP
 Contact Resistance: 30mΩ Max
 Withstand Voltage: 500V AC/DC
 Insulation Resistance: 1000MΩ Min
 Operation Temperature: -55°C to +105°C

Contact Material: Brass
 Contact plating: Au Or Sn over Ni
 Insulator Material: PBT+30%G.F. UL94V-0
 Sheet: Steel, Ni Plated
 Rivet/Harpoon: Brass, Ni Plated
 Screw: Steel, Ni Plated With #4-40
 Threaded Assembled

Ordering Information

6223A-XX M X N XX B 01

No. of Pins
 09 J25, 37P
 Product Type
 W=With Rivet
 M=With Rivet
 S=No Rivet
 Lock With Screw
 Heavy Rivet
 With Screws (Dont lock)

Contact Plating
 SO=Gold Plating
 S3=100%Gold/Tin
 S4=150%Gold/Tin
 S5=300%Gold/Tin
 SN=Tin

Insulator Color
 B=Black
 U=Blue

PLNS	DIM "A"	DIM "B"	DIM "C"
09	30.81	24.99	16.90
15	39.14	33.32	26.38
25	51.60	47.04	39.00
37	69.32	63.50	56.43

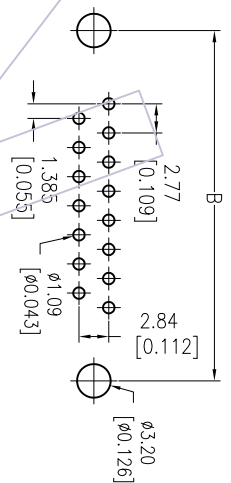
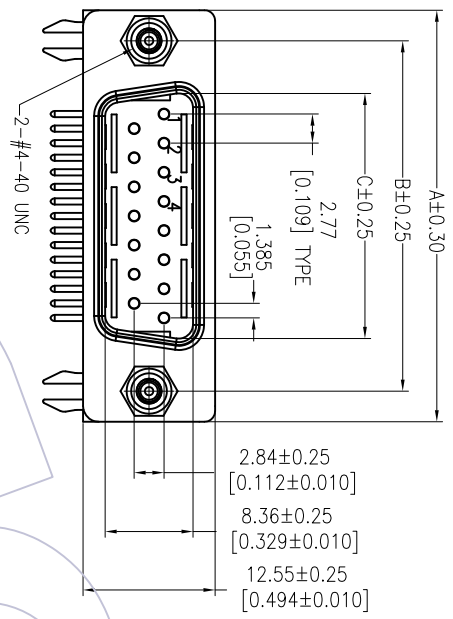

Recommended P.C.B Layout (Top Side)
 (PCB BOARD TOLERANCE ±0.05)

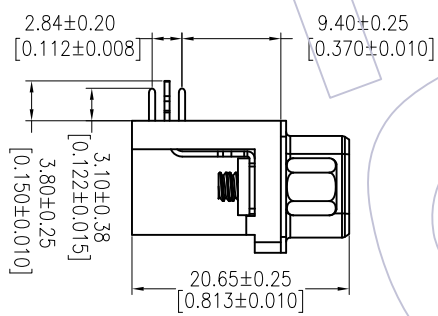
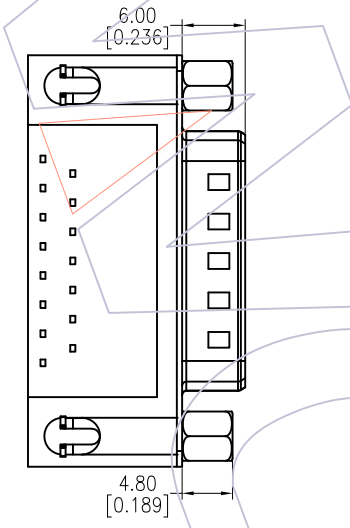

6223A-XXMWNXXB01

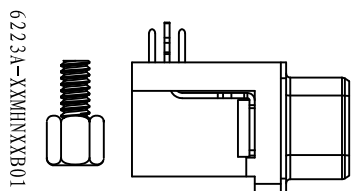
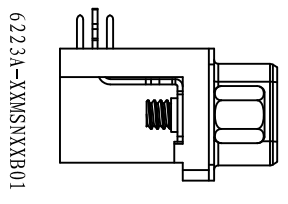
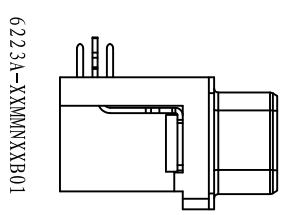

REV	DATE	MODIFICATION DESCRIPTION	CHANGE	OPERATION	DRAW	DATE	SCALE	FIT	PART NO.	TITLE:	WCON-Dongguan	WCON-Kunshan
A1	2014/04/09	Modify	△	XX	Allen	2014/04/09	mm	A4	6223A-XXMWNXXB01	D-SUB MALE CONNECTOR	Tel: +86 769 85358920	Tel: +86 512 57468408
A0	2012/12/06	NEW	---	X.XXX	CHECK		1/1	SHEET		9.40 FOOTPRINT RIGHT ANGLE TYPE	Fax: +86 769 85358915	Fax: +86 512 57468468
REV	DATE	MODIFICATION DESCRIPTION	CHANGE	DIM	APPROVE	DATE	PROJ.		Customer NO.		E-mail: sales@wcon.com	E-mail: sales@wcon.com



Http: www.wcon.com

WCON-Dongguan
 Tel: +86 769 85358920
 Fax: +86 769 85358915
 E-mail: sales@wcon.com

WCON-Kunshan
 Tel: +86 512 57468408
 Fax: +86 512 57468468
 E-mail: sales@wcon.com