

HSF

NOTES:

Rated Current:1.0AMP.
 Contact Resistance:20mΩ Max.
 Withstand Voltage:500V AC/DC
 Insulation Resistance:1000MΩ Min.
 Operation Temperature:-40°C to +105°C

Contact Material:Brass
 Contact Plating:Au or Sn Over Ni
 Insulator Material:PA9T+33%G.F UL94V-0 BK

Ordering Information

1320-12 XX XX M XXX C R XX

No. of Pins Per Row:02~50	Contact Plating G0=Gold Flash G3=10u"Gold G4=15u"Gold G5=30u"Gold S0=Gold Flash/Tin S3=10u"Gold/Tin S4=15u"Gold/Tin S5=30u"Gold/Tin SN=Tin SM=Matte Tin	Pin Length L=B+D+2.0+ $\frac{W-1.27}{2}$ Standard:061=6.1 072=7.2 082=8.2	Insulator C=PA9T	Series No. 01~99	Packing A=Tray T=Tube P=Tube+CAP R=Tape&Reel+CAP
------------------------------	---	---	---------------------	---------------------	--

Item	Pin Length	W	E	B	Mating
Standard	6.1	5.50	2.50	1.90	2321
	7.2	5.50	2.50	3.00	2334
	8.2	5.50	2.50	4.00	2344
Alternate					

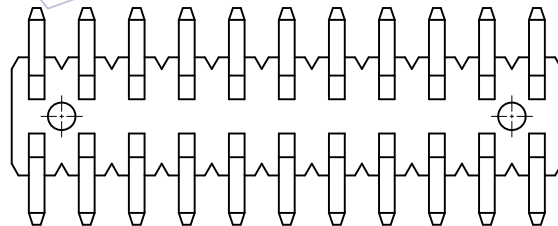
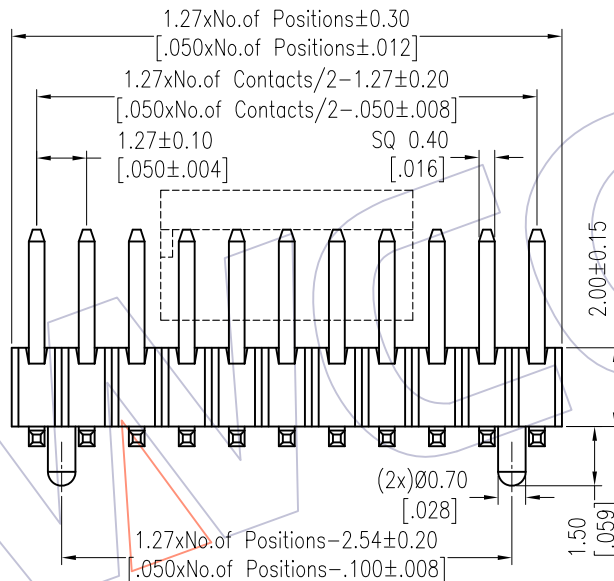
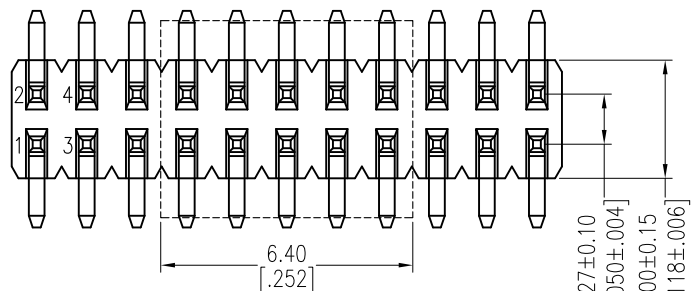

Recommended P.C.B Layout (Top Side) (PCB BOARD TOLERANCE±0.05)

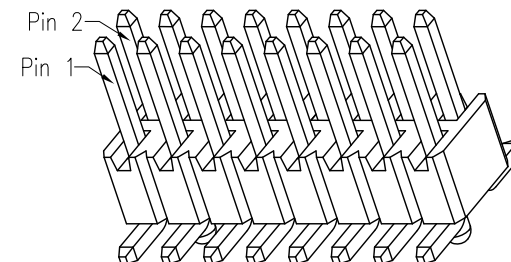
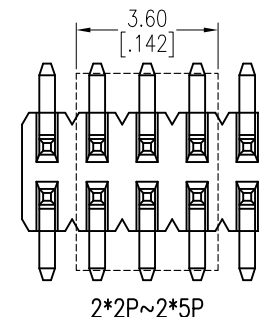
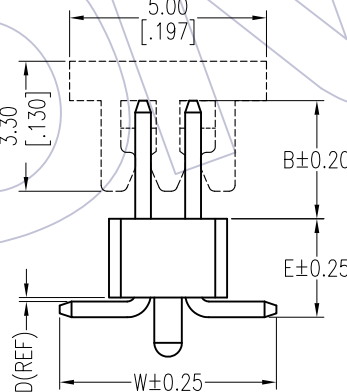
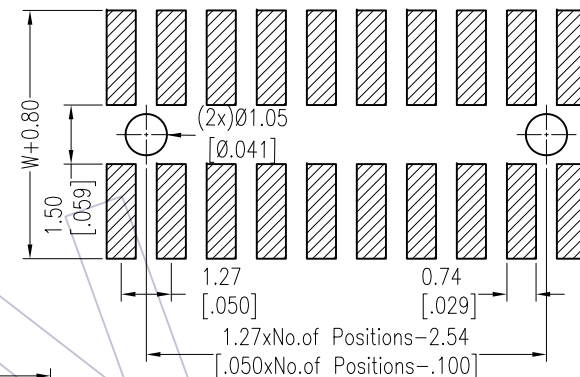

OPERATION	DRAW	DATE	SCALE	Fit	PART NO.
x.X ±0.40	William Chen	2018/01/17	UNIT	mm [inch]	1320-12XXXXMXXXCXXX
x.XX ±0.25	CHECK	DATE	SIZE	A4	TITLE: 1.27 Pin Header, DUAL ROW, SMT, WITH POST, H=2.0
x.XXX ±0.15	APPROVE	DATE	SHEET	1/1	Customer NO.
Angle ± 3'			PROJ.		
DIM TOL					

WCON

Http: www.wcon.com

WCON-Dongguan Tel: +86 769 85358920 Fax: +86 769 85358915 E-mail: sales@wcon.com	WCON-Kunshan Tel: +86 512 57468408 Fax: +86 512 57468468 E-mail: sales@wcon.com
---	--

REV	DATE	MODIFICATION DESCRIPTION	CHANGE
A2	2018/01/17	MODIFY PART NO.	-----
A1	2013/02/16	Mofidy Drawing	-----
A0	2012/03/22	NEW	-----